



**PACIFIC**  
WHOLESALE DISTRIBUTORS

# External Shutter Manual

**ecce**  <sup>®</sup>  
**SHUTTERS**  
**Aluminium**

# TABLE OF CONTENTS



1

## **INTRODUCTION**

4

2

## **ORDERING AND MEASURING PROCESS**

7

Tips for Filling Out the Order Form

7

Standard Special Comments

7

Measuring the Opening

8

    IN Measurements

8

    OUT Measurements

8

    MS Measurements

8

Options & Specifications

10

Blade Sizes & Options

11

Top & Bottom Rail Sizes

12

Mid Rail Sizes

14

Stile Options

16

Tiltrod Options

17

Special Comments Glossary

18

Quick Reference Guide

19

3

## **MOUNTING METHODS**

23

Hinged Panels

25

    Framing for Hinged Panels

26

    Extra Framing for Hinged Panels

28

Fixed Removable & Fixed Non-Removable Panels

31

Double Hinged Panels

32

Pivot Hinged Panels

34

Bi Fold Panels

35

Locks

36

Sliding Panels

38

Bottom Wheel Sliding System

4

**SPECIAL REQUIREMENT WINDOWS & OPTIONS**

40

Privacy Screen

40

Drawing Requirements

41

Shaped Shutters

41

Factory Drawing

43

5

**ECO LITE ALUMINIUM SHUTTERS**

44

Top &amp; Bottom Rail Sizes

45

Mid Rail Sizes

45

Stile Options

45

6

**CARE & MAINTENANCE**

46

7

**WARRANTY & REPLACEMENTS**

47

Warranty Claims

Replacement Requests

8

**SWATCHES & SAMPLES**

52

# Elevate Your Home with Eco Aluminium Shutters

Our External Shutter range offers a comprehensive external custom made shutter range in our durable T5 Aluminium material.

Elegant and stylish Eco Aluminium will not only add value to a home; they are energy efficient, practical, and add a level of sophistication without sacrificing on functionality.

Eco Aluminium Shutters offer complete control from today's harsh elements enabling you to block Sun, Wind, and Rain while providing complete privacy by simply tilting the shutter blades.

All OPC Aluminium Shutters have a superior powder coat finish for longevity and they are easy to care for.

OPC Aluminium Shutters are expertly custom made to suit most External requirements. **Applications include hinged, fixed, sliding and Bifold.**

Alongside our **extensive standard 7 colour ranges are the option to custom powder coat to any Dulux colour**, offering a solution to suit any colour scheme.

Swatches and sales aids are readily available to support the ECO Aluminium Range.

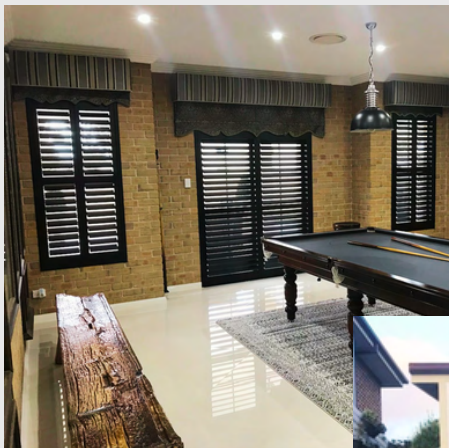

## Key Features of Eco Aluminium Shutters

- **Durability & Design:** Our standard T5 aluminium shutters with pressed aluminium blade caps give our shutters longevity and strength in harsh conditions.
- **Energy Efficiency:** Aluminium shutters allow you to block out the elements providing comfort and more temperature control.
- **Water & Weather Resistant:** Perfect for outdoor areas and internally for areas such as kitchens and bathrooms.
- **Privacy & Light Control:** Adjust the blades to control light, heat, air, and privacy at your convenience.
- **Low Maintenance:** Easy to clean.
- **Wide Range of Customisation:** Available in a variety of colours and finishes, with many different mounting options.



## Eco Aluminium

- Fully featured product with extensive design and colour options available
- T5 Aluminium offering excellent surface finish and is corrosion resistant
- **5 year** product and paint finish warranty\*
- High UV Powder Coated exterior available in **7 colours and Custom Dulux colours available on request**
- For Privacy Screen

**ecē**<sup>®</sup>  
**SHUTTERS**  
Aluminium



# ORDERING & MEASURING PROCESS

## Online Ordering - Available SOON

All orders MUST be submitted electronically in Excel with the latest version of Pacific Wholesale's **Eco Shutters Aluminium** Order Form.

References to the Shutter Order Form will be made throughout this manual. If you do not have the latest version of the Order form, please download from our website <https://www.pacificwholesale.com.au/order-forms/>, email your Sales Coordinator or [info@pacificwholesale.com.au](mailto:info@pacificwholesale.com.au) and request a copy today.

### Tips For Filling Out the Order Form

- Begin on the left-hand side of the order form and work your way across to the right. Many options will adjust automatically based on your previous selections.
- If a cell turns yellow, this indicates that additional information is needed or that there may be an issue with the order. Common causes include:
  - a) An incorrect number of panels has been entered for the given width – resulting in panels that are either too wide or too narrow. (Please Note: This is only a prompt; it won't prevent out-of-warranty sizes from being submitted.)
  - b) A Mid Rail is required.
  - c) T-Post quantity and positions are missing.
  - d) The layout code does not match the number of panels selected.
  - e) Missing information in the highlighted yellow cell.
- Every cell on the order form contains specification notes, options and advice.

### Standard Special Comments

A list of standard special comments is available in the drop-down menu on the order form. These comments help ensure that the shutters are manufactured to suit the specific opening and meet the customer's individual requirements.

Please refer to the glossary on page\_16 for explanations of each standard comment.

### Online Ordering

Online Ordering options are currently being developed and will be available soon.

# MEASURING THE OPENING

## IN

### Recess Fit (also known as Reveal Fit)

When measuring for a recess fit (inside the window reveal), take measurements in three places across both the width and the drop (height) of the window.

Use and record the smallest measurement in each direction, as this ensures the shutter fits within the narrowest point of the opening.

The factory will automatically apply a small deduction to each side to allow for proper clearance and fit of the frame.

*Please Note: All measurements must be provided in millimetres (mm).*

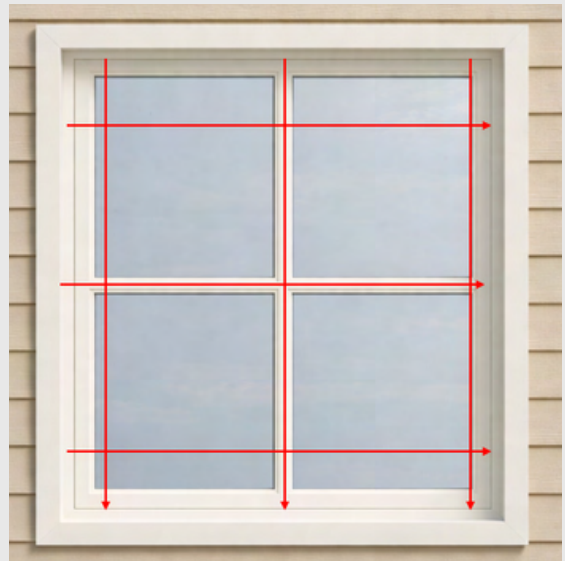

Minimum Clearance	63mm Blade	89mm Blade	114mm Blade
L Frame	54mm	67mm	79mm
Z Frame Beaded	38mm	51mm	64mm
Z Frame Flat	51mm	64mm	76mm

Factory IN Deductions	
All Z Frames	4mm from opening width, 4mm from opening height
All L Frames	4mm from opening width, 4mm from opening height
Top & Bottom U Channel	4mm from opening width, 4mm from opening height, 30mm from actual panel height
U Channel with Vertical H-Section	4mm from opening width, 4mm from opening height, 30mm from actual panel height, 25mm from actual total panel width

## OUT

### Face Fit (also known as Outside Fit)

When measuring for a face (outside) fit, take measurements in three places across both the width and the drop (height) of the opening. Record the largest measurement in each direction. These measurements should reflect where the outer edges of the shutter frame will be installed. No deductions are made for face fit measurements.

If the opening has an architrave, measure from the outside edge of one architrave to the outside edge of the opposite architrave. If there is no architrave, calculate the outside frame measurement by adding the width of the shutter frame to the recess (reveal) measurement.

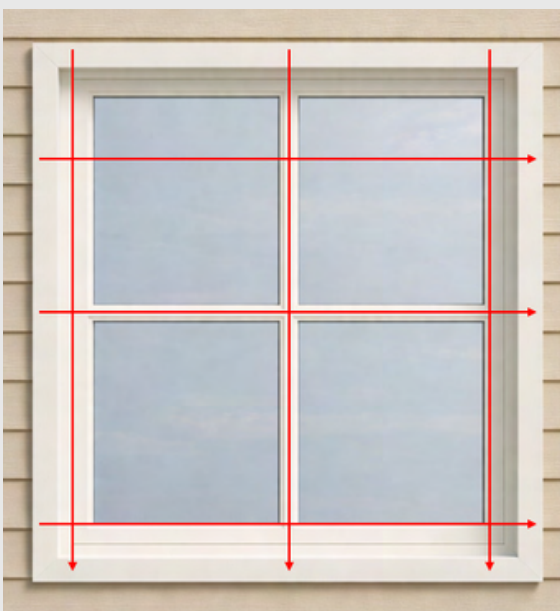

# MEASURING THE OPENING

## MS (Make Size)

Refers to the actual size of the panel(s) ordered.

A Make Size item **does not include frames**.

*Please note: Make Size orders do not allow for any deductions related to frames or the installation opening/application. **Measurements must be exact.***



Example (see arrows):

- If total panel width is 500mm.
- A single panel at 500mm will be supplied.
- If the quantity is entered as more than 1, each panel will be 500mm.

# OPTIONS & SPECIFICATIONS

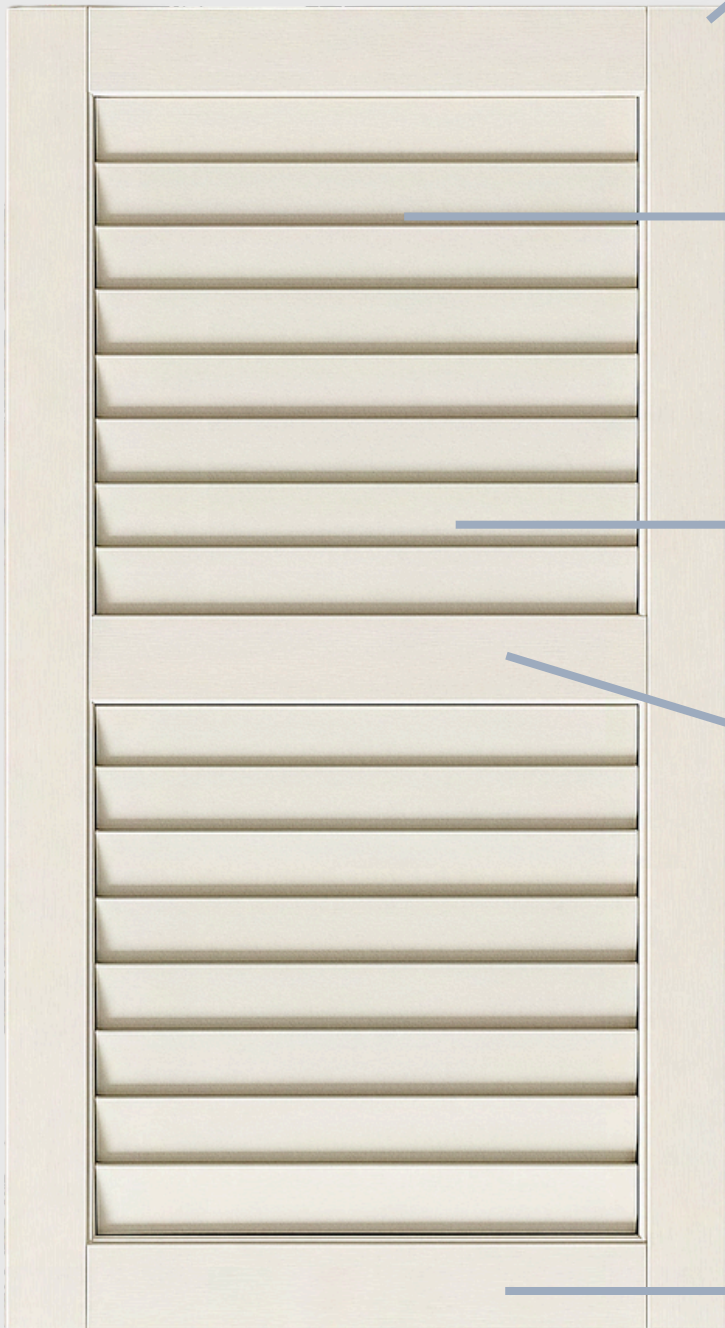

## **STILES**

These make up the sides of every panel.

## **TILTROD**

In line with our internal shutters for consistency, we have one tiltrod on the back/or front of the shutter on the hinged side.

## **LOUVRE BLADES**

The horizontal slats within the panel which are available in a **variety of sizes**.

## **MID RAIL**

These provide structural support for the panel and are required for panels over 1800mm, or if a customer specifically requests one, or if required to cover a mullion to allow the blades depth to operate.

## **TOP & BOTTOM RAIL**

These make up the top and bottom of every panel to provide strength through the panel. These differ in size depending on opening measurements, blade size and special comments.

# BLADE SIZES & OPTIONS

Eco Aluminium Shutter blades are available in 3 distinctive sizes, each made with reinforced elliptical Aluminium.

Please refer to the Shutter Range & Mounting Methods Reference Charts for Panel Dimensions including heights and widths.

*63mm*

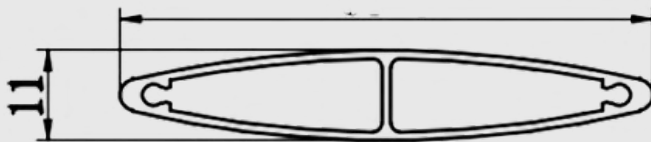

*89mm*



*114mm*

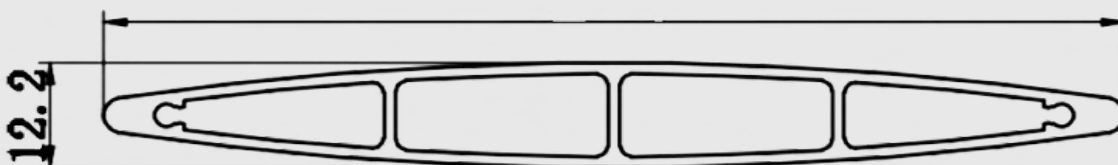

# TOP & BOTTOM RAIL SIZES

Please refer to the Shutter Range & Mounting Methods Reference Charts for Panel Dimensions including heights and widths.



*Top/Bottom Rail*

*Top/Bottom Rail Large*

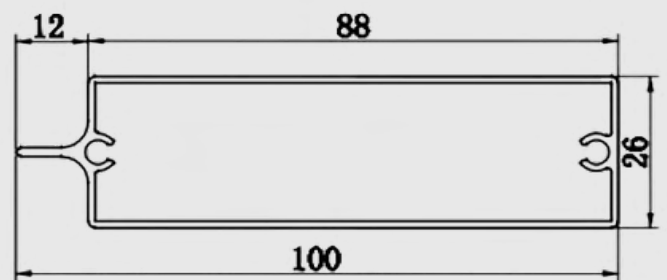
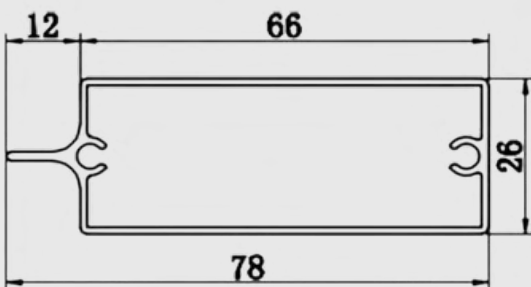

*Mid Rail*

*Adjustable Top/Bottom Rail*

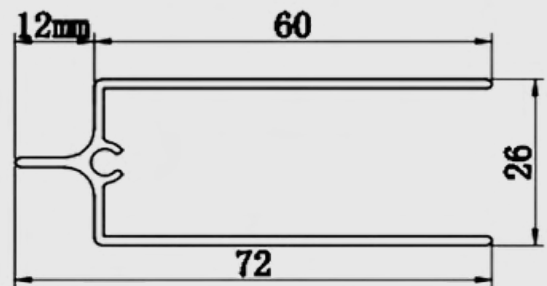
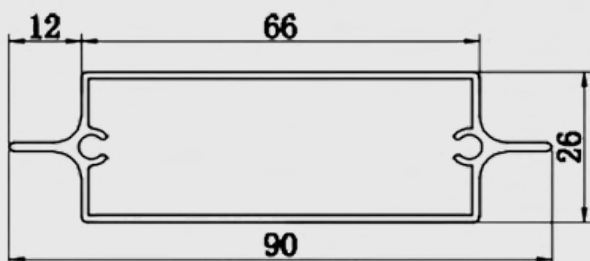

# TOP & BOTTOM RAIL INFORMATION

The height of the top and bottom rails will vary depending on the overall panel height and the number of blades required. An Adjustable Rail will be used to adjust the heights; this may leave a line where the rail finishes.

To ensure the strength and structural integrity of the panel, rail dimensions must remain within factory-approved specifications (see table below).

Please note that if rails are manufactured outside of these guidelines, the panel warranty will be void.

Top/Bottom Rail Specification			
	Min. Size	Max. Size	Mounting Method
	78mm	140mm	Standard Hinged or Fixed Shutter
	78mm	140mm	Bi Fold or Sliding

*Above specifications are within warranty coverage*

# MID RAIL SIZES

Please refer to the Shutter Range & Mounting Methods Reference Charts for Panel Dimensions including heights and widths.

To ensure consistency across the opening, we offer a 90mm mid rail. Please check the following specifications on where to measure from for the mid rail.

Where a second Mid Rail is required, you are only able to mark the lowest mid rail as critical, in order for even spacing of louvres throughout the opening.

## *Mid Rail*

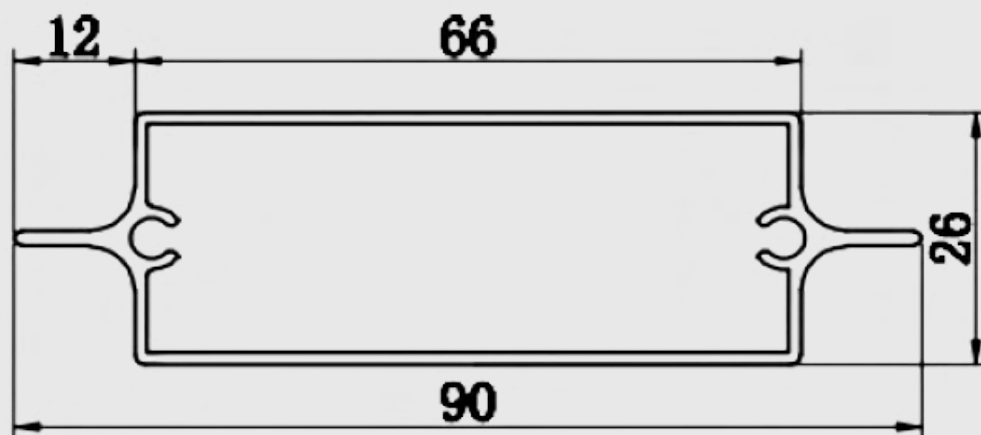

**ece**®  
**SHUTTERS**  
**Aluminium**

# MID RAIL - INFORMATION

A Mid Rail is required for panels exceeding 1800mm in height. The following information must be taken into consideration when using a Mid Rail.

- When a Mid Rail is required, its position must be measured from the **bottom of the opening** to the **centre point** of where the Mid Rail is to be located.
- While every effort is made to place the Mid Rail in the exact position specified, slight variances may occur depending on the overall panel height. If this is not specified, the factory reserves a **Mid Rail Adjustment Allowance (MAA) of ±40mm up or down.**
- If the Mid Rail location is critical, you **must select "Critical Mid Rail"** in the Special Comments for each relevant line item on the order form. We recommend marking the Mid Rail position as "Critical Mid Rail" in the Special Comments section
- If some flexibility is allowed, please indicate this in the Special Comments. For example:
  - If the window mullion to be covered is 30mm high, and the Mid Rail is 80mm high, it can be positioned up or down by 25mm and still cover the mullion.
    - In this case, note: **“MR can move ±25mm.”**
- This flexibility can assist in achieving a more balanced panel or aligning blade heights between adjacent panels.
- For shutters **over 2500mm** in height, **two Mid Rails are required.** However, **only one Mid Rail can be designated as Critical.** Please indicate this in the Special Comments for the applicable line item.
- The **second Mid Rail cannot be marked as Critical**, as its placement will depend on blade overlap and required spacing. Its height will vary based on the total panel height and number of full blades needed.

ALLOWABLE MID RAIL TOLERANCES	
Louvre Size	Tolerances +/-
64mm	25.4mm
89mm	38.1mm
114mm	50.8mm

- Example (see arrows):
- Gross open height 1500mm
  - Mid Rail @ 600mm (Bottom of opening to centre of mid rail)

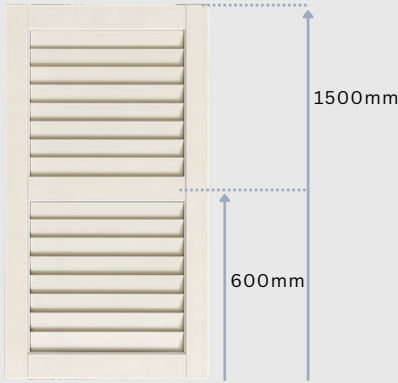

# STILE OPTIONS

## Standard Stile

A standard shutter panel is made using aluminium core **60mm beaded stiles** by default.

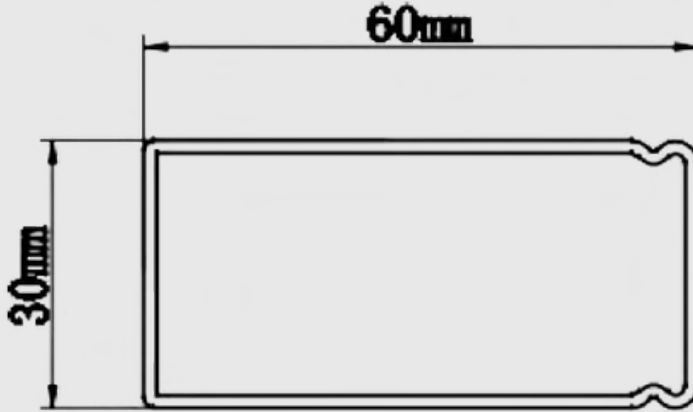

## Astragal Stile (D Mould)

The Astragal Stile, also known as a **D Mould**, is an optional feature designed to minimise light gaps between two adjoining panels. It can be specially ordered to enhance light control and privacy where panels meet.

To ensure correct placement, please clearly specify the **D Mould location** in your **Layout Code**:

- Example 1: **L-DR** (D Mould on the left side of the **right** panel)
- Example 2: **LD-R** (D Mould on the right side of the **left** panel)

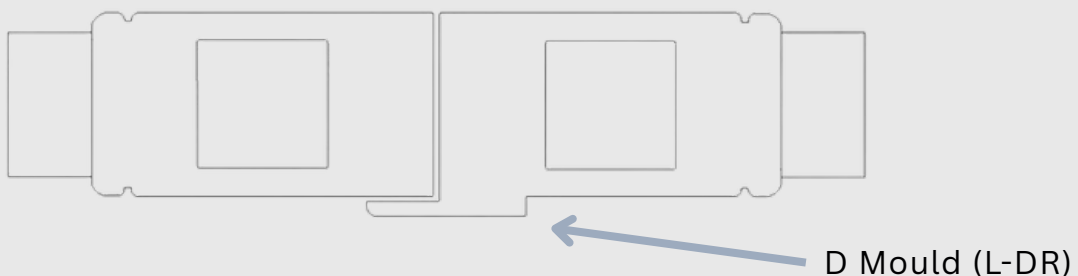

# TILTROD OPTIONS

## Hidden Tiltrod

Available for Eco Aluminium ranges, the Hidden Tiltrod offers a clean, minimalist look by positioning the mechanism discreetly on the back/or front of the panel.

This sleek colour-coordinated **aluminium tiltrod** is recessed into the side of each louvre blade and placed on the hinged side, making it virtually invisible from the front. Built for durability, the tiltrod is constructed from high-quality aluminium.

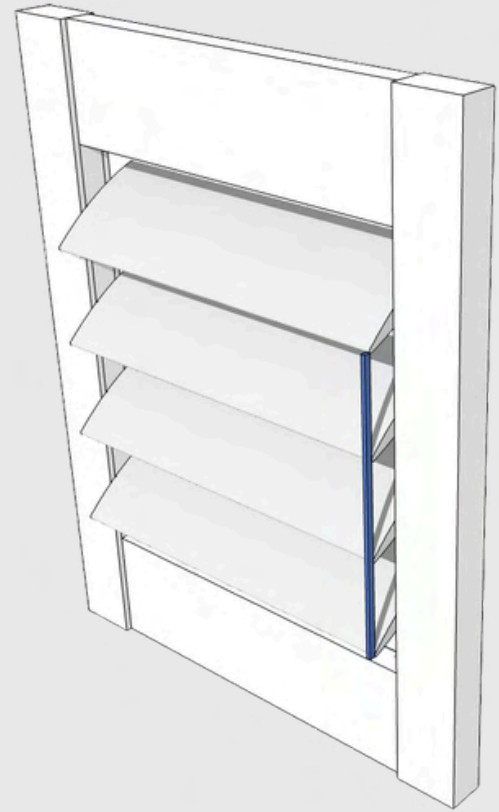

*Each Hidden Tiltrod control is split at 21 louvres for 63mm blades (11 blades top and 10 blades bottom) and at 17 louvres for 89mm blades (9 blades on top and 8 blades on bottom). and between 17-25 louvres for 114mm. If requested, **tilt rods can be split at specified locations** using the Special Comments section on the order form.*

**ece**®  
**SHUTTERS**  
**Aluminium**

# SPECIAL COMMENTS GLOSSARY









<b>Standard Special Comment</b>	<b>Definition</b>
All Even Panels	Factory will manufacture all panels and T posts evenly without having to supply specific T post measurements.
Critical Mid Rail	The factory will not make any adjustments to the midrail measurement without querying how the midrail location may effect warranty.
Customer Rework	When ordering replacement parts or whole line item at customer charge.
Do Not Split Tiltrod	The factory will not split the tiltrod without querying how this may effect function or warranty.
Horizontal T Post	When a horizontal T post is required or the measurement in the Mid Rail section is a Horizontal T post measurement (please ensure a measurement is supplied).
Mid Rail May Be Up To 40mm Higher/Lower, Unless "Critical Mid Rail"	The factory may adjust the midrail up to 40mm higher or lower to suit the blade quantity and top and bottom rails. This is standard if "Critical Mid Rail" is not selected.
Side By Side	The factory will match marked side by side line items appearance. This includes midrails, blade quantity and top and bottom rails. If the GOH is different than the shutter it is next to, please advise if the shutter should match up from the top or bottom of the opening.
Split Tiltrod In Half	The factory will split the tiltrod in half.
Split Tiltrod In Half Above Mid Rail	The factory will split the tiltrod in half above the mid rail.
Split Tiltrod In Half Below Mid Rail	The factory will split the tiltrod in half below the mid rail.
Warranty Remake	The line item or specific parts of the line item will be reviewed for a warranty claim and then manufactured with no charge to the customer. Original order number, description of what is required as well as images are a requirement and if not supplied all parts will be processed at customer charge.

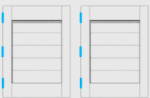

# PACIFIC

WHOLESALE DISTRIBUTORS









<b>OVERVIEW:</b>		Eco Aluminium
<b>MATERIAL</b>		T5 Aluminium
<b>LEAD TIME</b>		4-6 Weeks
<b>WARRANTY</b>		5 Year Paint and Product <sup>1</sup>
<b>PAINT</b>		High UV Powdercoating
<b>COLOURS</b>		7 x Standard Colours Dulux Custom Colours available <sup>2</sup>
<b>OPTIONS:</b>		
<b>BLADE SIZES</b>		63mm elliptical 89mm elliptical 114mm elliptical
<b>TILTROD</b>		Hidden
<b>STILES</b>		60mm Beaded D Mould Mould available
<b>SPECIFICATIONS:</b>		
<b>HINGED PANEL (width)</b>		1000mm maximum 200mm minimum
<b>DOUBLE HINGED (max. width)</b>		1000mm total width over 1 x panels maximum
<b>FIXED REMOVABLE PANELS (width)</b>		1000mm maximum 200mm minimum
<b>BI-FOLD WITH TRACK (panel width)</b>		1000mm maximum 200mm minimum
<b>SLIDING PANELS Bottom Wheel System (panel width)</b>		1000mm maximum

<sup>1</sup> Shutter hardware warranty 5 years. Refer to full PWD product warranty documents

<sup>2</sup> Surcharge applies, please refer to pricing sheets

<sup>3</sup> Only one mid rail can be critical

# ECO ALUMINIUM SHUTTERS QUICK REFERENCE GUIDE

SPECIFICATIONS:	63mm	89mm	114mm
COMBO PANELS (width per pair) 	N/A	N/A	N/A
MID-RAIL REQUIRED 	Above 1800mm panel height	Above 1800mm panel height	Above 1800mm panel height
2nd MID-RAIL REQUIRED 	Above 2500mm panel height <sup>3</sup>	Above 2500mm panel height <sup>3</sup>	Above 2500mm panel height <sup>3</sup>
PANEL HEIGHT Hinged / Fixed / Slide 	3500mm maximum	3500mm maximum	3500mm maximum
PANEL HEIGHT Bi-fold 	3000mm maximum	3000mm maximum	3000mm maximum
PANEL HEIGHT Double Hinged 	2100mm maximum	2100mm maximum	2100mm maximum
BAY & CORNER POSTS	N/A	N/A	N/A
SHAPES 	Available <sup>2</sup>	Available <sup>2</sup>	Available <sup>2</sup>
BLADE LOCKS	Black / White	Black / White	Black / White
FLUSH BOLTS	White / Silver / Black	White / Silver / Black	White / Silver / Black
SAFETY LOCK	White	White	White
KEY LOCK	White	White	White
HANDLE LOCK	Black / White	Black / White	Black / White
HINGE COLOURS	White/Black/Silver	White/Black/Silver	White/Black/Silver
COLOUR LIST	<b>Standard:</b> White/Pearl/Black Textured/Silver/Golden Oak/Light Cedar/Walnut *Comes with metal end caps  <b>Custom:</b> Dulux Custom Colours available <sup>2</sup>	<b>Standard:</b> White/Pearl/Black Textured/Silver/Golden Oak/Light Cedar/Walnut *Comes with metal end caps  <b>Custom:</b> Dulux Custom Colours available <sup>2</sup>	<b>Standard:</b> White/Pearl/Black Textured/Silver/Golden Oak/Light Cedar/Walnut *Comes with metal end caps  <b>Custom:</b> Dulux Custom Colours available <sup>2</sup>
WARRANTY	<b>Colour Fastness:</b> 5 years <b>Custom Colour Fastness:</b> 5 years <b>Structure:</b> 5 years <b>Hardware:</b> 5 years <b>Stainless Steel Hardware:</b> 5 years	<b>Colour Fastness:</b> 5 years <b>Custom Colour Fastness:</b> 5 years <b>Structure:</b> 5 years <b>Hardware:</b> 5 years <b>Stainless Steel Hardware:</b> 5 years	<b>Colour Fastness:</b> 5 years <b>Custom Colour Fastness:</b> 5 years <b>Structure:</b> 5 years <b>Hardware:</b> 5 years <b>Stainless Steel Hardware:</b> 5 years

<sup>1</sup> Shutter hardware warranty 5 years. Refer to full PWD product warranty documents

<sup>2</sup> Surcharge applies, please refer to pricing sheets

<sup>3</sup> Only one mid rail can be critical

# FRAMES

## HINGED FRAMES

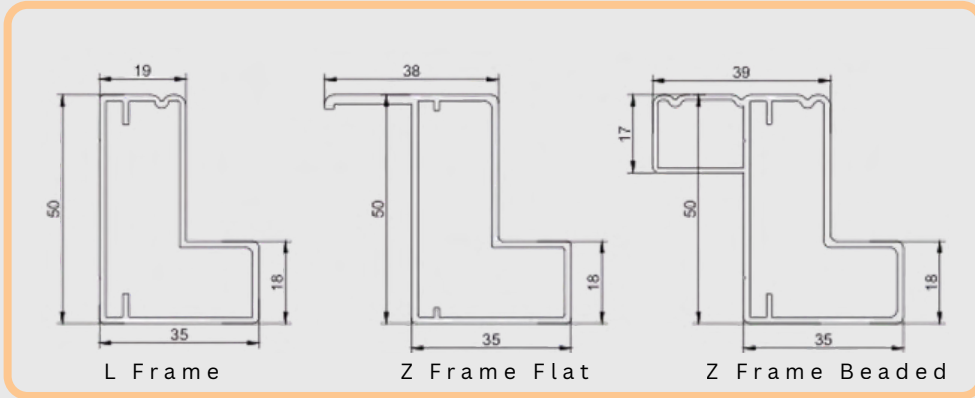

## T POSTS, POSTS & PELMET

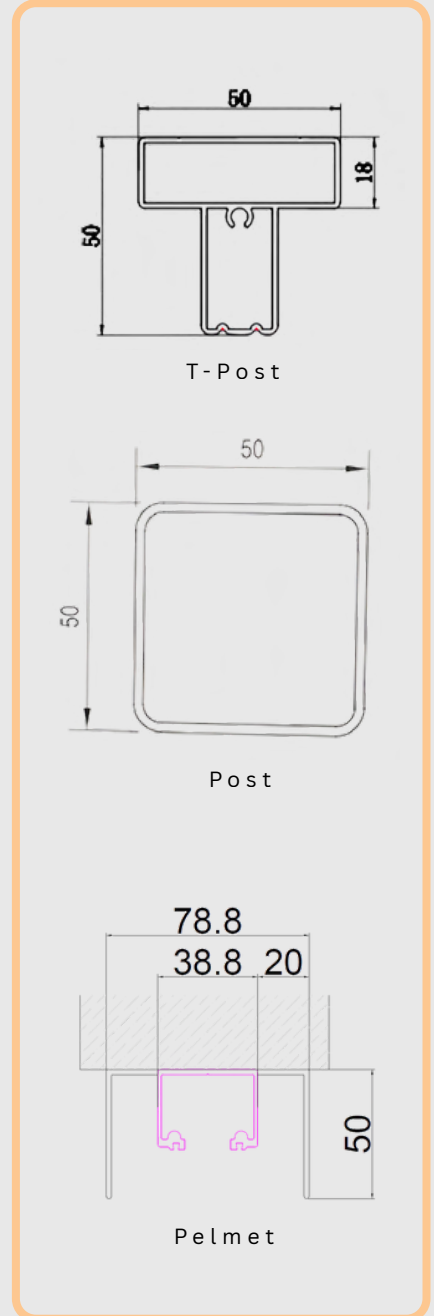

## FIXED FRAMING

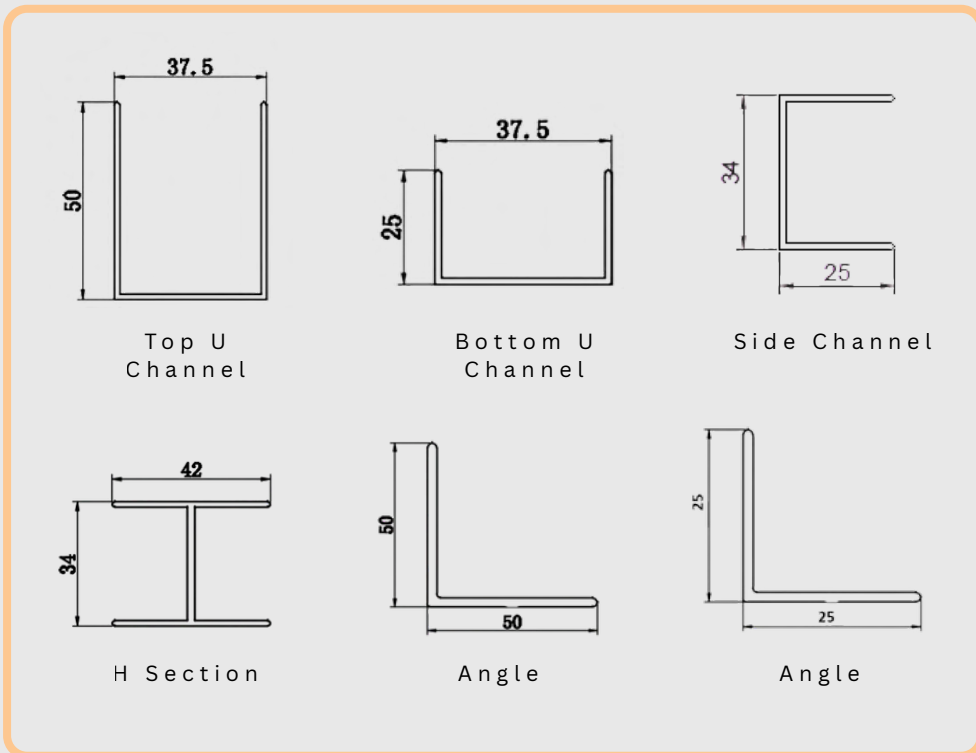

<sup>1</sup> Shutter hardware warranty 5 years. Refer to full PWD product warranty documents  
<sup>2</sup> Surcharge applies, please refer to pricing sheets

# ANGLES

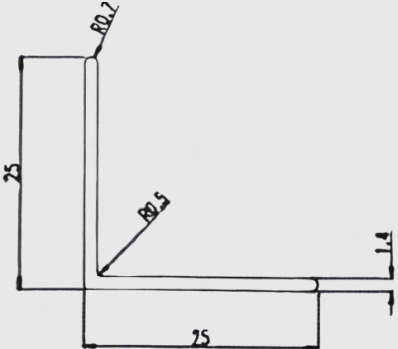
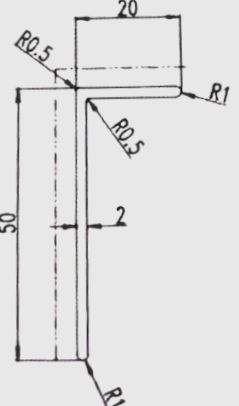
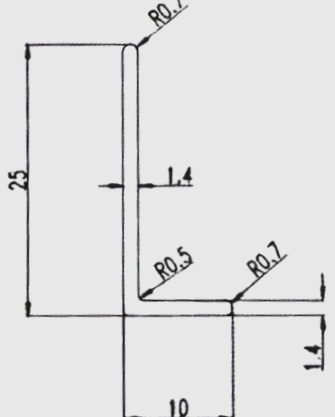
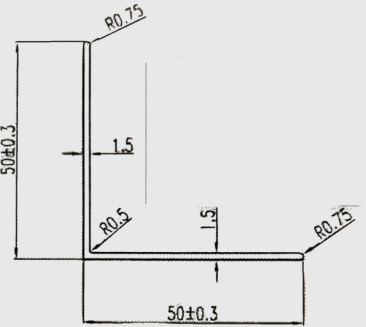
Sizes	Drawings	Colour Option
25 * 25 * 1.4mm		White / Pearl / Black / Silver / Golden Oak / Light Cedar / Walnut
50 * 20 * 2mm		White / Pearl / Black / Silver / Golden Oak / Light Cedar / Walnut
25 * 10 * 1.4mm		White / Pearl / Black / Silver
50 * 50 * 1.5mm		White / Pearl / Black / Silver

<sup>1</sup> Shutter hardware warranty 5 years. Refer to full PWD product warranty documents  
<sup>2</sup> Surcharge applies, please refer to pricing sheets

# MOUNTING METHODS

## **A) Hinged Panels**

Available in Eco Aluminium Shutters

Hinged Panels are popular and versatile option for window shutters. They are typically mounted using frames and non-mortise stainless steel hinges that connect the panels to the frame.

## **B) Fixed Panels**

Available in Eco Aluminium Shutters

Utilising U Channel sections, L Shaped Angles and H Sections, and fixed panels have been a favourite option for exterior aluminium shutters.

## **C) Double Hinged Panels**

Available in Eco Aluminium Shutters

A Double Hinged Panel involves two panels hinged together without the need for any tracking. **NOTE: maximum width per pair of panels is 1000mm total**

This configuration is ideal in situations where a wider single panel cannot open fully due to obstructions like a tap or outdoor kitchen fixture. **Double hinged panels above 1500mm height are not advised due to excessive weight on the hinges.**

## **D) Pivot Hinged Panels**

Available in Eco Aluminium Shutters

Pivot Hinges offer a clean and practical solution when no frame is required. Installed at the top and bottom of the panels, they allow for smooth operation while maintaining a minimalist look.

Pivot Hinges are available in Stainless Steel to suit outdoor elements.

# MOUNTING METHODS

## **E) Bi Fold Panels**

Available in Eco Aluminium Shutters

Bi Fold Panels are perfect to use as room dividers or for covering sliding doors or outdoor kitchen patios.

They fold neatly to the side, providing uninterrupted access and a clear view when open.

## **F) Sliding Panels**

Available in Eco Aluminium Shutters

Sliding Panels are a flexible solution, most commonly used for sliding doors but suitable for a variety of applications.

- Bottom Wheel System
  - Bottom Wheel System alleviates the pressure of top hung panels. With an easy to adjust bottom wheel, the weight of the shutter now rests at the base of the track. The top channel now reduces the light gap at the top and removes the need for a pelmet.

# A) HINGED PANELS

Due to their construction using T5 Aluminium, these shutters are lighter than other window coverings. When combined with Hinged or Bi fold installation methods, this allows for larger panels to be manufactured within warranty.

Please refer to the Shutter Range & Mounting Methods Reference Charts for Hinged Panels minimum and maximum dimensions.

Layout Codes for Hinged Panels:

When configuring the “Layout Code” for Hinged Panels, the following letters apply:

- ‘L’ - Left Hand Side Hinge
- ‘R’ - Right Hand Side Hinge
- ‘T’ - T Post (for hinging panels off)
- ‘D’ - D Mould

*Please Note: When ordering, the **Panel Quantity** must match the **Layout Code**.*

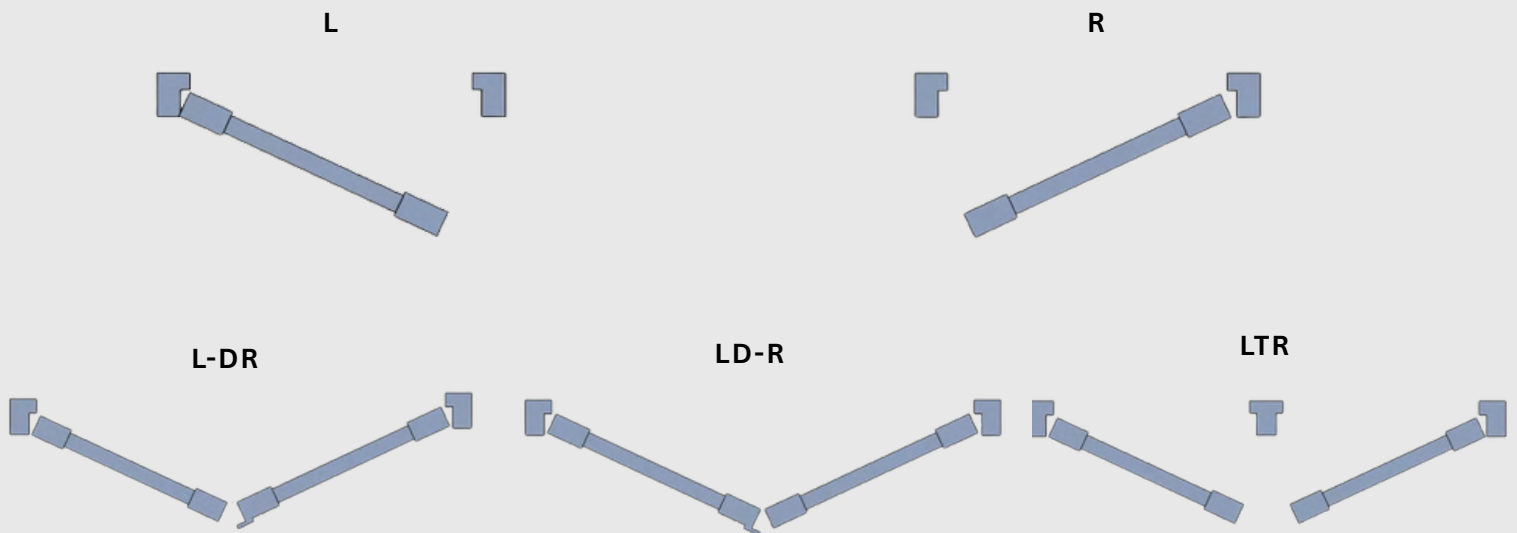

# FRAMING FOR HINGED PANELS

## Inside Mount

Frames are highly recommended for reveal fit installations. They allow the shutter panels to be hung squarely, even when the window opening itself may not be perfectly square. Any uneven gaps between the frame and the reveal can be filled using matching No More Gaps, creating the appearance of a true, square window frame. It's essential to ensure the frame is properly packed and level during installation.

## L Frame

An L Frame is commonly used for inside mount (reveal fit) installations and are ideal for windows with deep or consistent reveals. The frame is fixed inside the opening, creating a square and stable structure for mounting the shutter panels. This is particularly useful in openings that are slightly out of square, as the frame provides a level base for the panels to operate smoothly.

L Frames are also helpful in clearing any obstructions within the reveal, such as window handles or mullions, allowing full blade rotation. This frame type delivers a clean, modern look with minimal projection, making it a versatile option for a wide range of window styles and applications

## Z Frames

Z Frames are a popular choice for installations both with and without existing architraves. Designed to wrap around the edge of the reveal, they are ideal for disguising out-of-square window openings and delivering a clean, symmetrical finish.

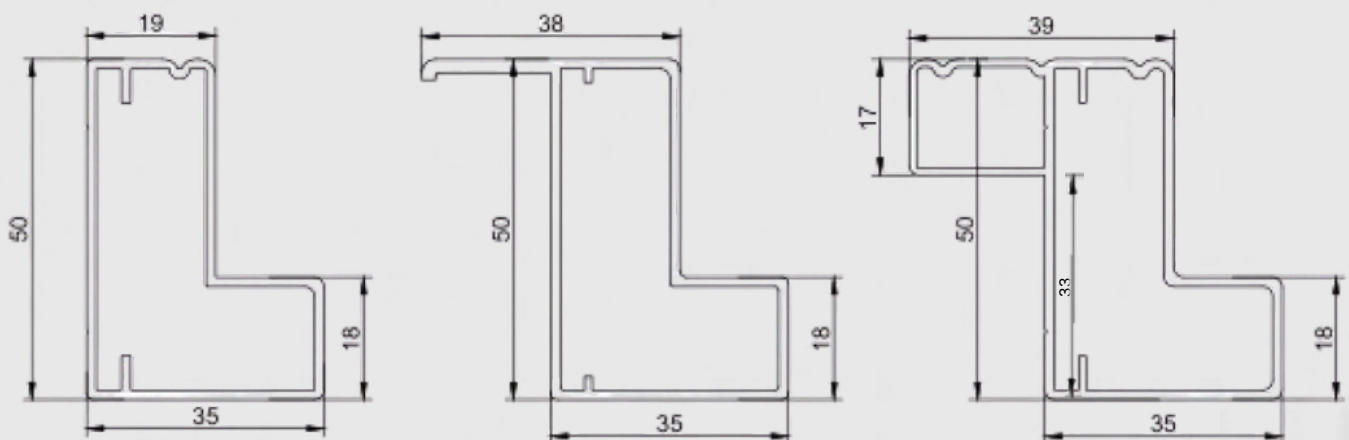

*L Frame*

*Z Frame Flat*

*Z Frame Beaded*

# FRAMING FOR HINGED PANELS CONT.

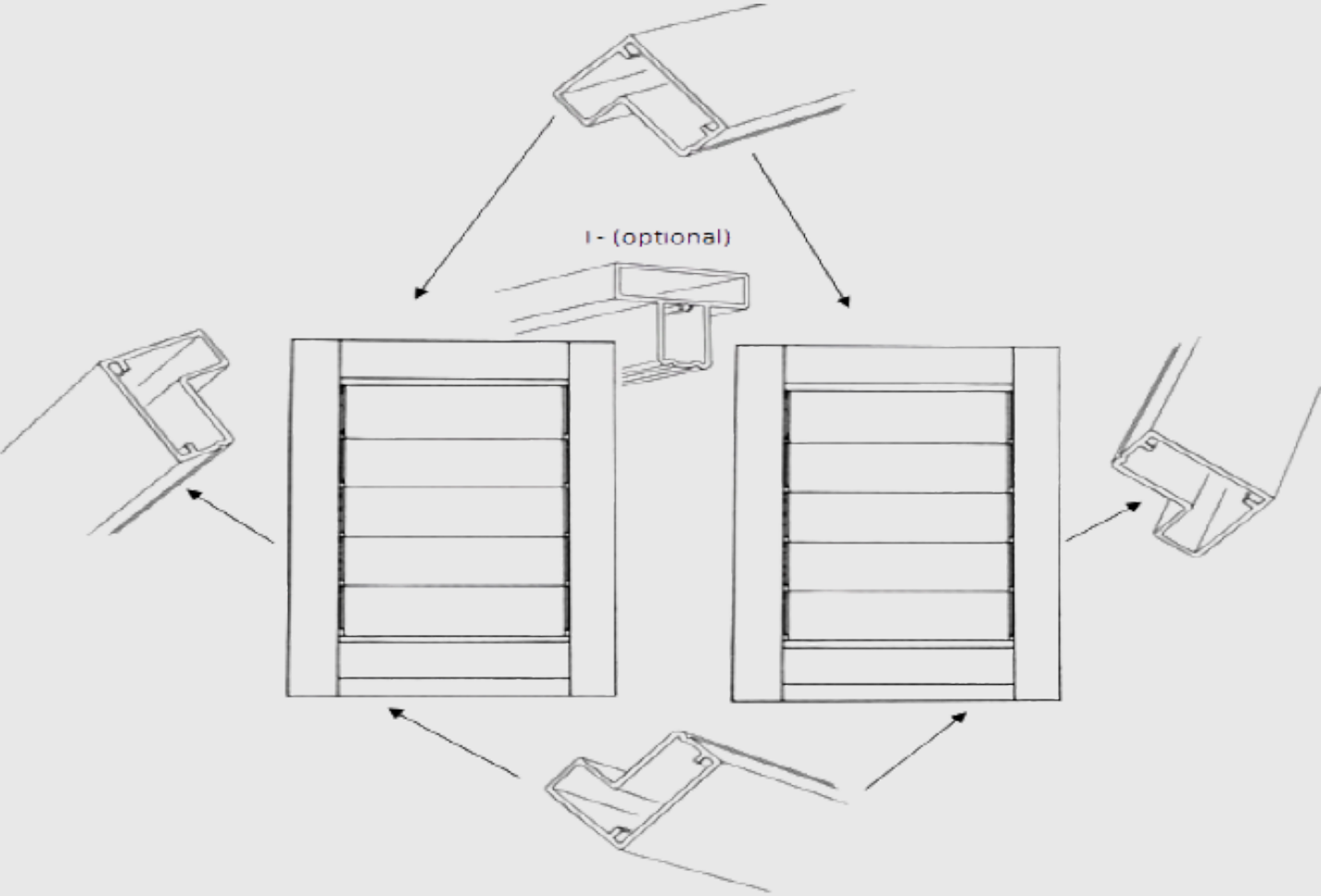

# FRAMING FOR HINGED PANELS

Standard factory deductions for **inside mount** framed shutters are 4mm off the width dimension provided and 4mm off the height dimension provided.

## Reveal Fit L Frame Inside Mount (Top View) Width



## Reveal Fit L Frame Inside Mount (Side View) Height



# FRAMING FOR HINGED PANELS

Standard factory deductions for **Inside Mount** framed shutters are 4mm off the width dimension provided and 4mm off the height dimension provided.

## Z Frame Flat (Top View) Width

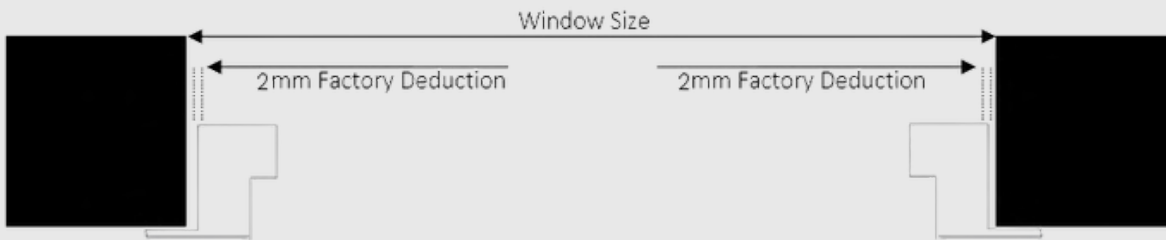

## Z Frame Beaded (Side View) Height



# FRAMING FOR HINGED PANELS

Measurements for **Outside Mount** Face Fit frames are from 'outside of frame' to 'outside of frame' for both the width and the height. **No deductions will be taken** from the measurements provided.

Unlike internal shutters, the ECO Aluminium Shutter program will use the same internal framing, and the fitter is to fix through the frames.

**Face Fit L Frame Outside Mount (Top View) Width**



**Face Fit L Frame Outside Mount (Side View) Height**



# B) FIXED PANELS

## Fixed Panels – Clean, Minimal, and Practical

Fixed panels offer a sleek, streamlined appearance without the need for hinges or swinging operation—making them the ideal solution for hard-to-access areas, permanent fixture, or at elevated wall heights.

Removable panels provide easy access for when cleaning or maintaining the area.

## Fixed Removable Panels Using U Channels – A Streamlined Look with Removable Convenience

Fixed panels using U channels are installed using a deep U Channel at the top and a shallow U Channel at the bottom, allowing them to easily be lifted and removed from the opening.

For a more secure, fixed installation, angles or side channels can be added. These are optional on the left and right of the face side, while rear angles are available as an additional upgrade for enhanced light control and security.

Please refer to the Shutter Range & Mounting Methods Reference Charts for Fixed Removable Panels minimum and maximum dimensions.

Any additional extras required must be noted in the Extras Section of the Order Form.

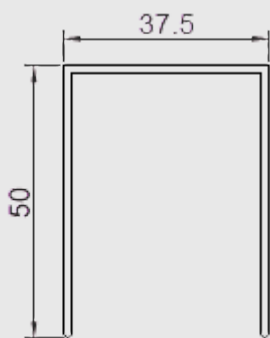

Large Top U Channel

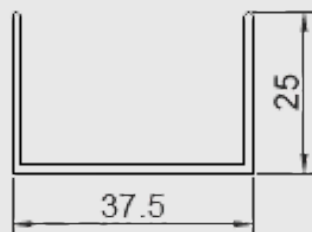

Small Bottom U Channel

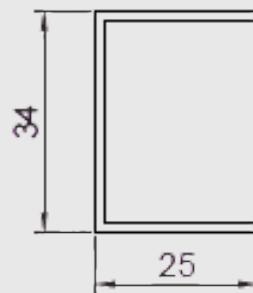

Side Channel

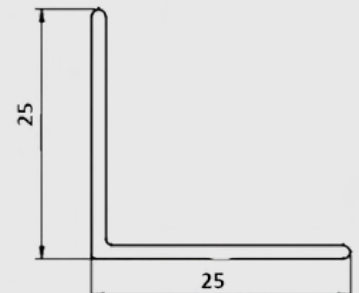

Angle 25\*25

# C) DOUBLE HINGED PANELS

A Double Hinged Panel consists of two panels hinged together, eliminating the need for tracking. This configuration is ideal in situations where a wider single panel cannot fully open due to obstructions such as taps, sinks, or built-in fixtures.

**Double hinged panels above 1500mm height are not advised due to excessive weight on the hinges.**

To enhance light control, a D mould can be fitted between each pair of double-hinged panels for a neater finish.

Double Hinged Panels make it possible to install up to four panels in a single opening without the use of T-Posts. However, standard width limitations must be followed:

- **A double-hinged pair can span up to 1000mm in total**

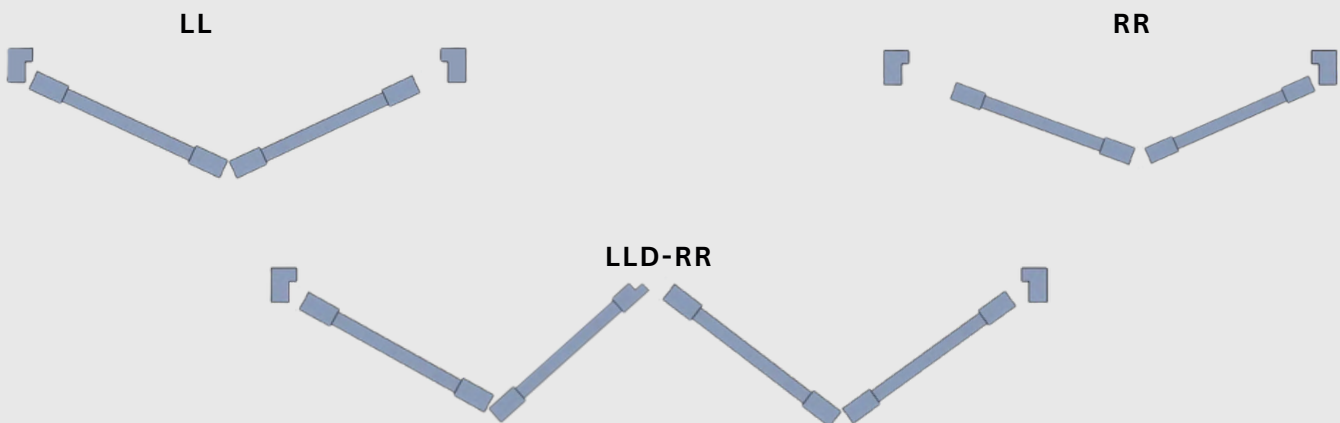

## D) PIVOT HINGED PANELS

For a sleek, frameless look, pivot hinges are the perfect solution for Eco Aluminium Shutters - allowing smooth top and bottom panel operation without the need for a frame. Available in a premium stainless steel finish, these hinges seamlessly suit both Reveal Fit and Face Fit installations. Enhance your shutters with this stylish and practical option (surcharges apply).

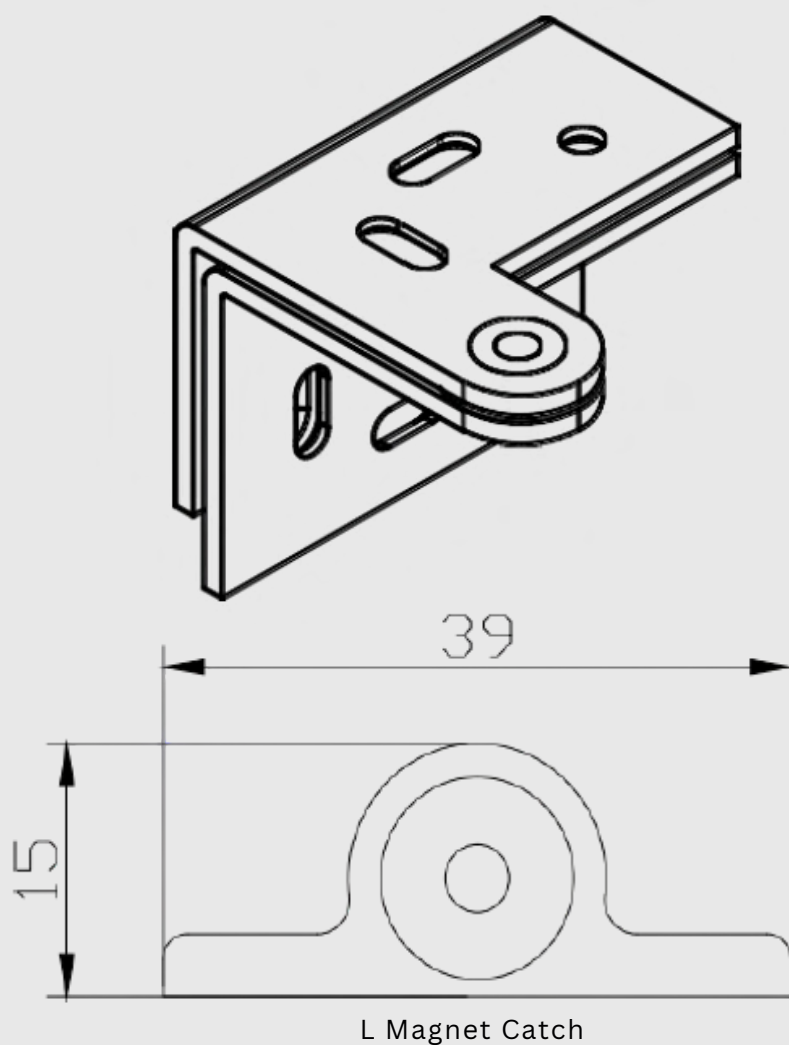

# E) BI FOLD PANELS

Bi fold panels are the perfect solution for creating flexible, stylish spaces. Whether you're using them as room dividers to define living areas or as elegant covers for sliding doors, these panels fold neatly to the side, maximizing your usable space. When open, they provide seamless access and an unobstructed view, allowing natural light to flow freely and enhancing the sense of openness in any room. Designed for smooth operation and lasting durability, bi fold panels combine functionality with a clean, modern aesthetic—making them a smart choice for both contemporary and traditional interiors.

Please refer to the Mounting Methods Reference Chart for Bi Fold Panels minimum and maximum dimensions.

## Layout Codes for Bi Fold Panels

The layout codes for Bi Fold Shutters are the same as Hinged Panels, which are used to configure the specified direction of the panels:

- 'L' - Left Hand Side Hinge
- 'R' - Right Hand Side Hinge

Below are some examples of Bi Fold configurations



LL



RR



LLRR



LLLLRRRR

# E) BI FOLD PANELS

## Tracking for Bi Fold Panels

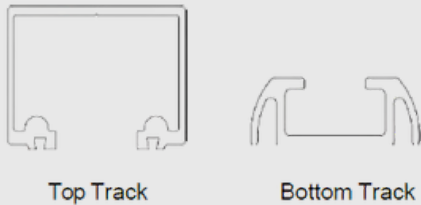

## Key Lock / Safety Lock (Surcharges Apply)

Commonly used on Hinged or Bi Fold shutter doors, to enhance security and ensure a firm, reliable closure. This not only improves overall door stability and helps with security but also helps prevent unwanted movement or forced entry—offering both peace of mind and a clean, streamlined finish.

Key Locks feature both top and bottom shoots, while Safety Locks feature a single, adaptable shoot that can be installed at the top or bottom of the panel.

\*Safety Lock available in standard range only.

## Blade Lock / Louvre Lock (Surcharges Apply)

Commonly used on Bi Fold or Hinged shutter doors, to enhance security and ensure a firm, reliable closure. This not only improves overall door stability and helps with security but also helps prevent unwanted movement or forced entry—offering both peace of mind and a clean, streamlined finish.

## Flush Bolts (Surcharges Apply)

Flush bolts are commonly used on Bi Fold shutter doors, to enhance security and ensure a firm, reliable closure. Recessed neatly into the panel stile these stainless steel bolts maintain a smooth, flush surface while securely locking the panel in place. This not only improves overall door stability but also helps prevent unwanted movement or forced entry—offering both peace of mind and a clean, streamlined finish.

## Handle Lock (Surcharges Apply)

Handle Locks provide a high-quality, secure, and practical solution for protection.

## Hardware for Bi Fold Panels

This will include

- Track Stop
- Wheel Carrier
- Carrier Plate
- Spring Guide
- Top Pivot
- Bottom Pivot



Key Lock



Safety Lock

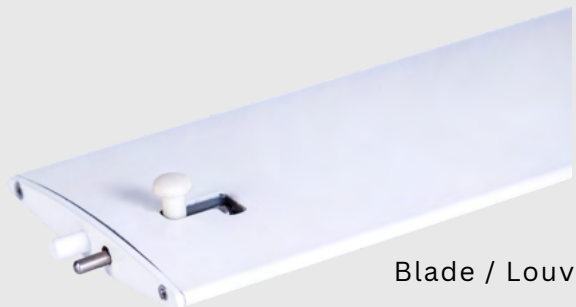

Blade / Louvre Lock



Flush Bolt



Handle Lock

# F) SLIDING PANELS

Sliding shutters are a smart and stylish solution for large openings such as sliding doors, wide windows, and open-plan areas. Their space-saving design allows panels to glide effortlessly along a track, eliminating the need for outward swing and making them ideal for rooms with limited space or nearby furniture. Featuring a clean, modern look, sliding shutters offer a sleek finish that complements both contemporary and traditional interiors. With adjustable louvres, they provide excellent control over light and privacy—delivering the functionality of standard shutters with the added ease of a sliding mechanism. Designed for durability and low maintenance, sliding shutters are built to last. Their flexible configuration options can be tailored to suit your space, combining practicality with refined aesthetics. Available in an easy to install **Bottom Wheel System**.

## Layout Codes for Sliding Panels

- 'B' Back – meaning the panel is placed on the back track.
- 'M' Middle – meaning the panel is placed on the middle track (only when 3 tracks are required).  
These panels will ONLY slide in the CLOSED position.
- 'F' Front – meaning the panel is placed on the front track



BF



BFB

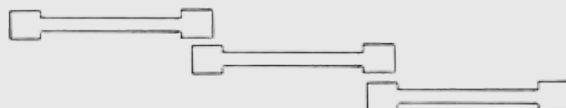

BMF

# F) SLIDING PANELS

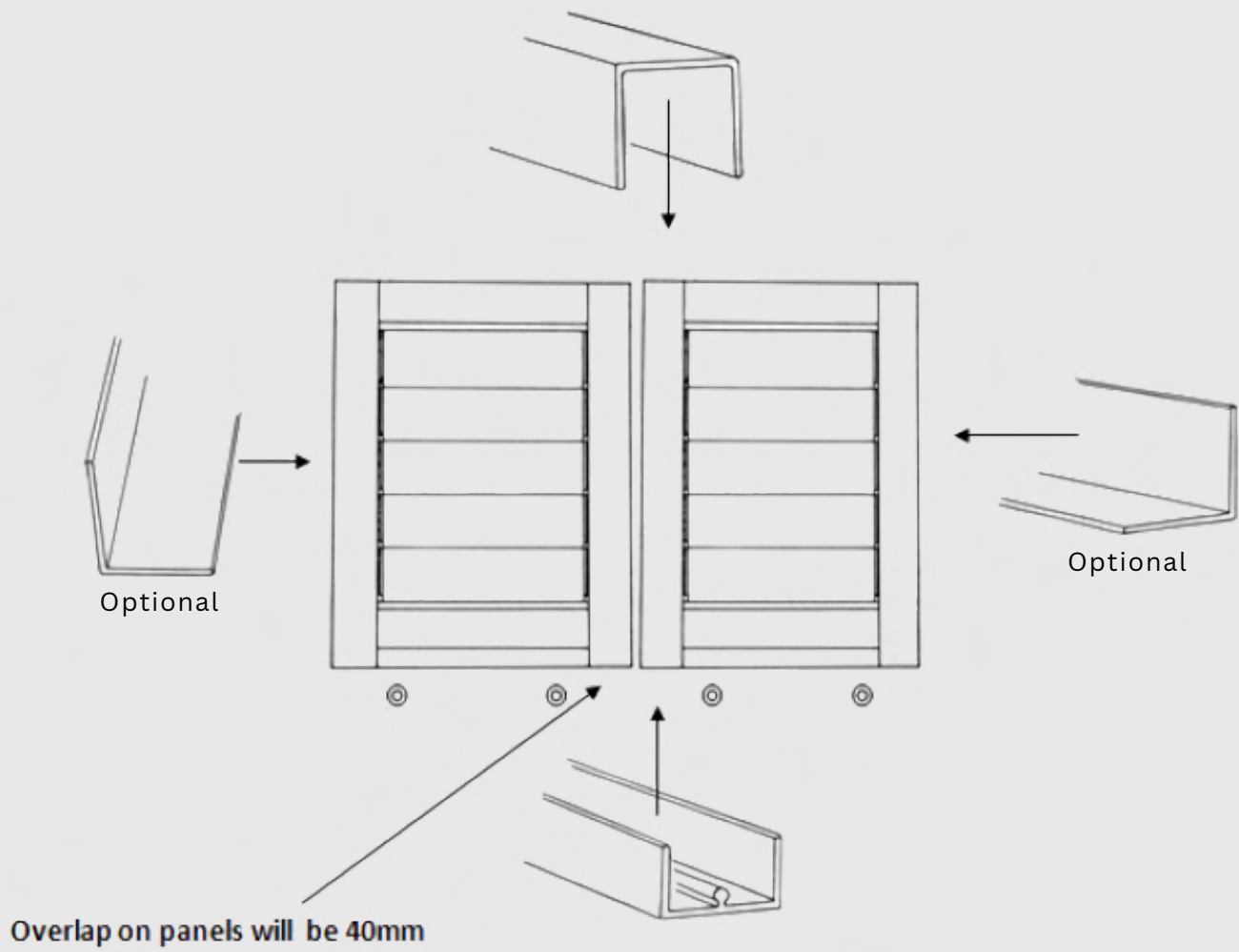

\*\*\* Panels will be evenly divided UNLESS specified \*\*\*

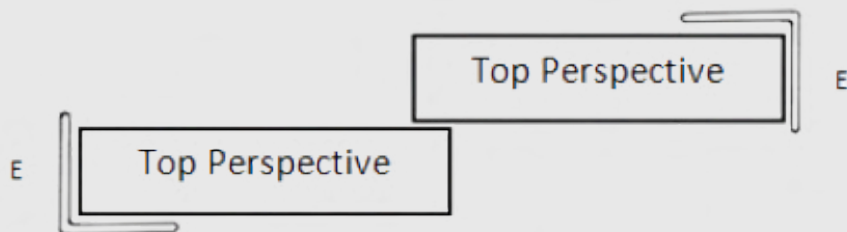

# F) SLIDING PANELS

## Bottom Wheel Sliding System

The Bottom Wheel Sliding System is our latest improvement to our Sliding Shutter Range.

The weight of the shutters now rest on our adjustable bottom wheel, the polymer wheels reduce noise and minimise track wear. Making it easier to install and improves performance and durability.

### Tracking for Bottom Wheel Sliding Shutters

### Hardware for Bottom Wheel Sliding Shutters

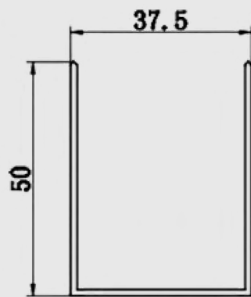

Large Top U Channel

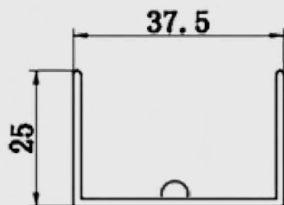

Small Bottom U Channel



Sliding Wheel

# G) EXTRA HEADBOARDS

## Available Sizes:

115mm x 23mm

150mm x 23mm

190mm x 23mm

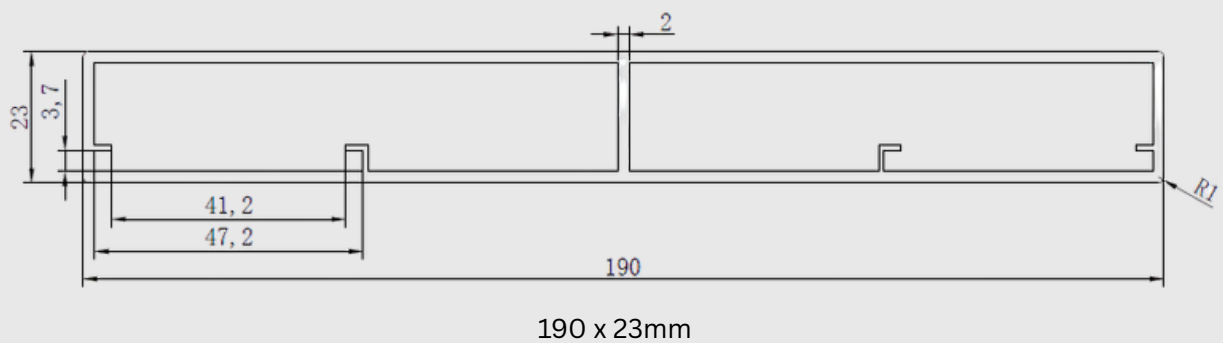
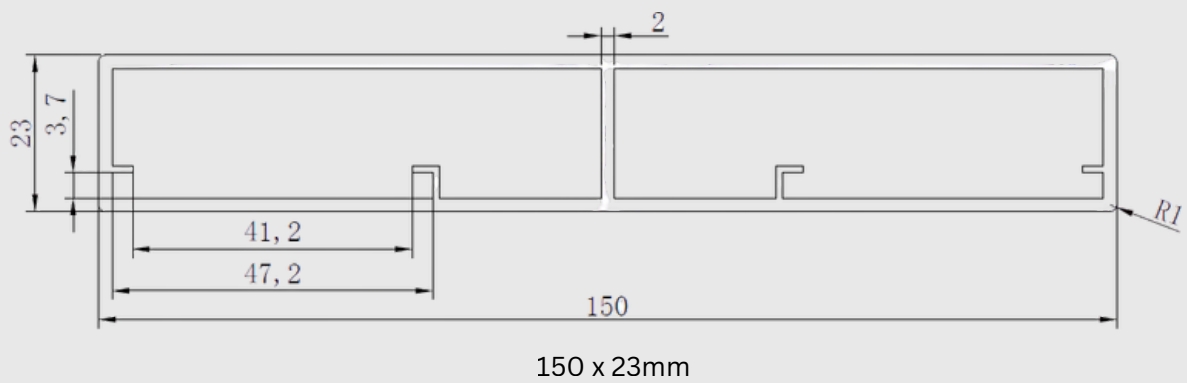
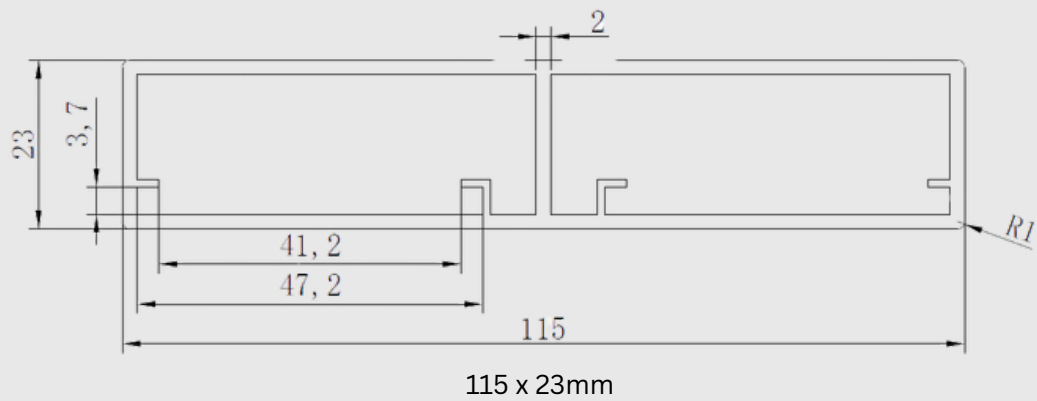

# SPECIAL REQUIREMENT WINDOWS & OPTIONS

There is a wide range of solutions available for windows with special requirements. Including, slopes & triangles

Because each situation varies based on the window type, location, and product selection, this section outlines the key considerations and requirements needed to manufacture these specialised shutters accurately and effectively.



## **PRIVACY SCREEN**

Fixed pitch louvre panels. Great screening options for privacy and durable shading solutions.

Available in 63mm, 89mm, and 114mm blades.

Blades assembled in 50mm flat bars to side.

Available in raked and triangle shapes.

When ordering, you must select MS (Makes Size) on the order form.

A range of angles, 50mm x50mm posts and feet are available extras for privacy screen. During the installation process, the installer can customise the extras onsite.

# SHAPED SHUTTERS

No two homes are the same – and some feature truly unique and eye-catching windows. Shaped Shutters are the perfect solution for bringing style and functionality to unusual window designs or wall cut-outs. Whether it's an a raked window or a triangle, our custom-made Shaped Shutters are designed to fit perfectly and stand out beautifully.

To ensure a precise fit, we require one of the following:

1. **A line drawing with angles** – perfect for straight-edged and geometric shapes like rakes, parallelograms, circles, equilateral or right-angle triangles

Factory drawings will be sent for approval prior to production and must be approved via email to confirm all details are correct.

## Drawing Requirements

To ensure accurate production of Shaped Shutters, please ensure the following requirements are met:

- All measurements must be included – This includes all straight-line dimensions and angles (in degrees). These must match the measurements provided on the Order Form (e.g., Gross Opening Width and Gross Opening Drop).
- Clear drawings only – all measurements must be clearly advised and if a mistake is made, clearly crossed out and re-written.
- Layout code – Clearly label the shape with its corresponding layout code.
- Identification details – Include the customer name and the Order Form line item number on the drawing.
- On-Site Photo's help! The more images supplied, the better understanding the factory and our team have of the opening requirements.

## Shaped Shutters Add On:

- All Available in standard colours
- Available blade sizes include 63mm, 89mm, and 114mm with metal end caps



# SHAPED SHUTTERS

## Shaped Shutters Gallery

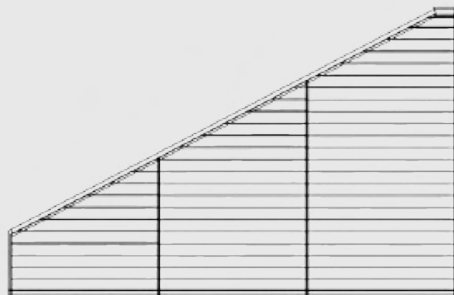
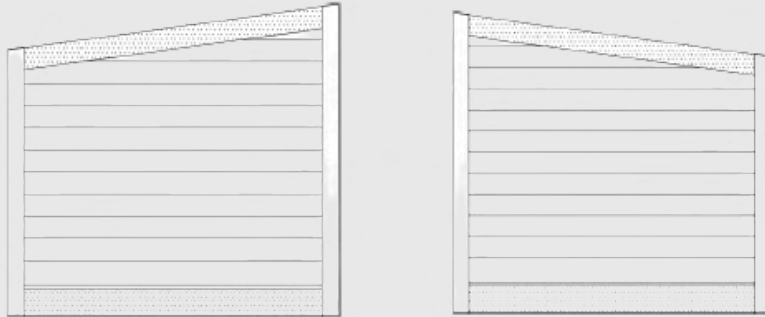

**Other shapes available on request and to be presented with drawing.**

# SHAPED FACTORY DRAWING E.G

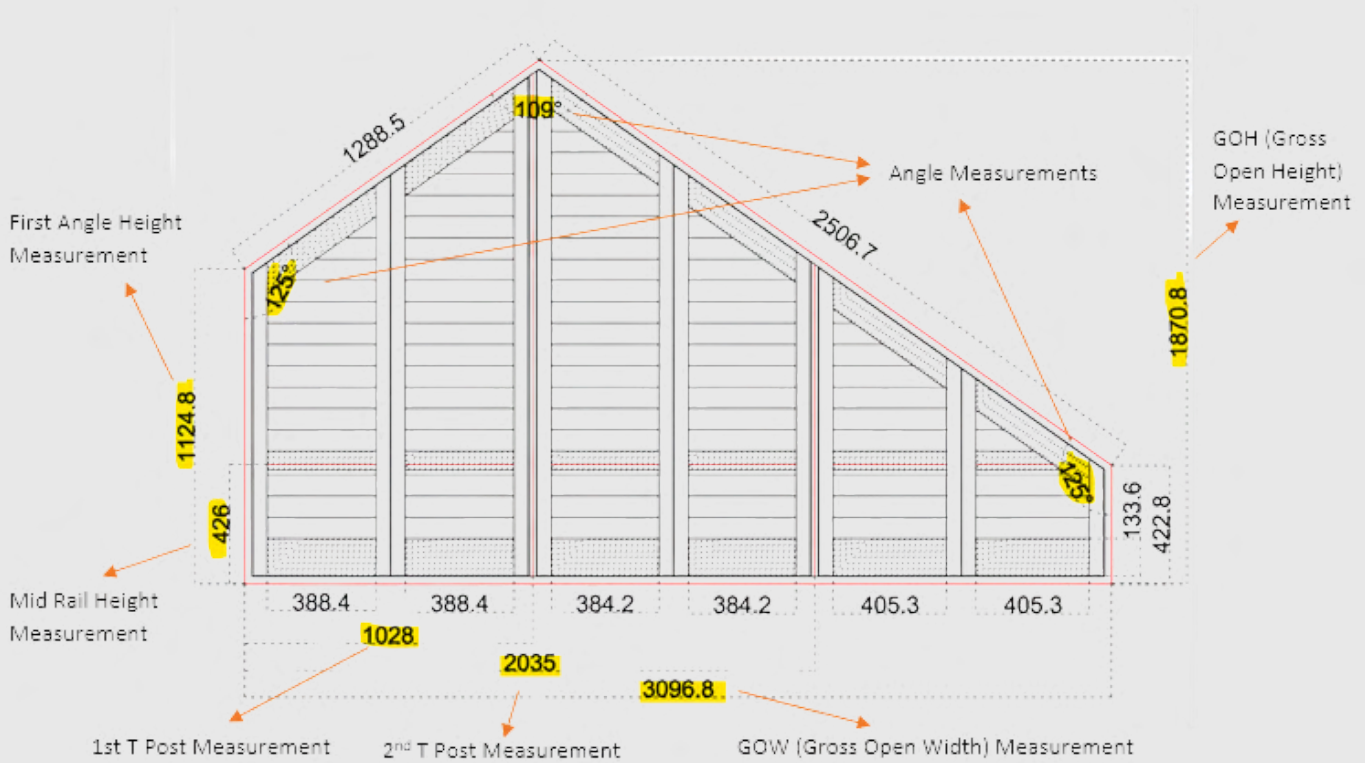

# ECO LITE ALUMINIUM SHUTTERS

- **Lighter Profile Design:** ECO Lite Aluminium Shutters provide elegance and sheer sophistication.
- **One Colour Option:** Vivid White
  - **Dulux Custom Colours Available** (surcharges apply)
- **One Directional Closure**
  - **Hinged / Fixed**
  - **Bifold & Sliding Available** (surcharges apply)
- **Plastic End Caps**
- **Great For Indoors**
- **Key Lock and Flush Bolts are available upon request** (surcharges apply)



# OPTIONS & SPECIFICATIONS

Please refer to the Shutter Range & Mounting Methods Reference Chart for Panel Dimensions including heights and widths

**Standard Stile**

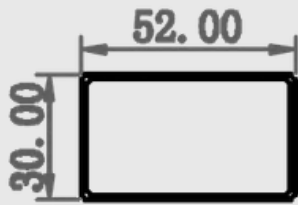

**Mid Rail**

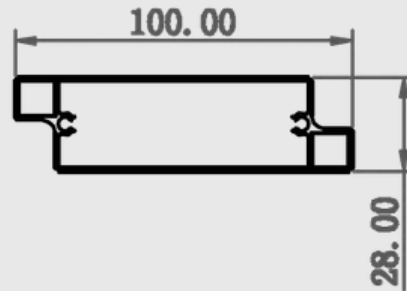

**Rail Sizes**

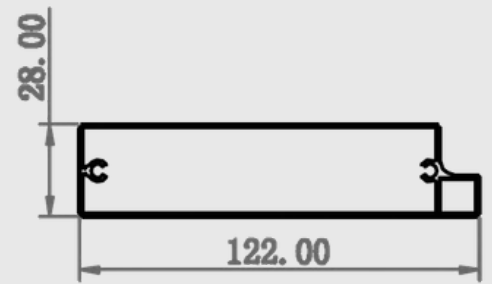
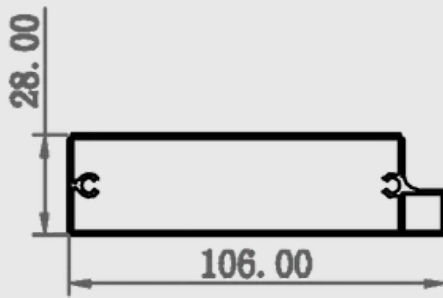
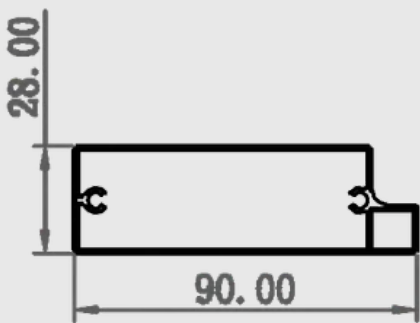

# CARE & MAINTENANCE

Over time, the surfaces of Eco Aluminium Shutter will naturally accumulate dust. Regular cleaning helps maintain their appearance and functionality.

- Routine Cleaning: Use a soft, damp cloth or brush for regular dusting. This will effectively remove surface dust and prevent buildup.
- Deeper Cleaning: For more thorough cleaning, use a solution of mild household dishwashing liquid and water. Apply with a soft cloth and ensure the surfaces are completely dried afterward.
- Stubborn Marks: For tougher dirt or stains, only use mild, water-based household cleaners.

## Special Considerations for Coastal or Damp Areas:

Hinges, magnets, and catch plates in coastal or humid environments should be cleaned regularly to remove airborne contaminants that may cause corrosion or pitting.

## Maintenance of Moving Parts:

Apply a food-grade silicone spray periodically to pivot points and moving components to reduce friction and prevent binding. Avoid using petroleum-based lubricants.

### CAUTION:

Do not use abrasive cloths, harsh chemicals, chlorine, or ammonia-based cleaners. These can damage the surface finish, shorten the life of your shutters, and void the warranty.

Corrosion Potential	Distance to Saltwater Area	Cleaning Schedule
Low (LCP)	20 km radius	Every 6 months
Moderate (MCP)	10 km radius	Every 3 months
High (HCP)	1 km radius	Every 3 weeks
Extreme (ECP)	500 meter radius	Every week

# WARRANTY & REPLACEMENTS

## **Warranty Claim - Remake**

We stand behind the quality of our shutters with a comprehensive warranty designed to give you confidence in your purchase. All Eco Aluminium shutters are backed by a warranty that covers manufacturing defects and transit damage. Pacific Wholesale are here to assist in reviewing and replacing any parts that fall under the warranty policy.

Our warranty is a promise that our product will perform as expected for a certain period of time. If something goes wrong due to a fault in materials, workmanship, or manufacturing, our warranty gives you the right to replacement components to repair the shutter, a replacement of defect parts of the shutter and in rare cases a complete replacement.

## **Key Warranty Points:**

- Covers defects – Our warranty covers things that are not your fault. Items received damaged, incorrect to how you originally ordered the item or with a manufacturing defect.
- Conditions apply – To stay valid, the product should first be trouble-shooted on site to fix any small misalignments or issues which may be caused in transit and needs to be used and maintained correctly while following our care and maintenance instructions. For example, shutters damaged by incorrect cleaning practices would not be covered by warranty.
- Proof is needed – You need to show proof of purchase, evidence in the form of photos or videos and a clear description of the problem to make a warranty claim.
- Component Replacements - Not all defects require the shutter to be replaced. Please refer to our Shutter Component Guide further down in the manual for parts and their purposes.

# WARRANTY & REPLACEMENTS

## **Customer Charge Replacements - Reworks**

While all of our shutters are built to last and backed by a comprehensive warranty, we understand that unexpected changes or situations can arise. A Customer Charge Replacement is a flexible option that allows you to order a replacement component, part or panel – even when the need falls outside of standard warranty coverage.

This service is ideal in situations such as:

- Updating your design or layout after installation
- Replacing a shutter damaged accidentally or due to general wear and tear
- Re-ordering due to measurement changes or adjustments
- Replacing lost or misplaced parts

At Pacific Wholesale we make the process easy and transparent: once the issue is identified, we will liaise with you on pricing and requirements, confirm the details with you, and arrange prompt delivery of the replacement. It's our way of ensuring you can always maintain the look and functionality you love – no matter the circumstance.

# WARRANTY CLAIMS

## Organising Warranty Replacements (Remakes)

To arrange a replacement under warranty – also referred to as a remake – we require one of the following two options. This will allow our team to promptly review the issue and assist you in resolving it for your customer.

### 1. Original Order Form and email to your Sales Coordinator.

a) Copy of the original order form.

b) A new order form, clearly showing the shutter(s) that need remaking. Please specify that the order is a remake on the order form – failure to do so may result in the original order being placed as a new order at full charge.

c) A detailed description specifying exactly what the concern is and exactly what panels/frames etc. need remaking. Failure to clearly specify this information may result in a longer lead time. More often than not the fastest solution to rectify a concern is to order only the parts required e.g. Louvre Blades and Pins, Framing Section etc.

d) Supporting photographs/videos illustrating any concerns. For example – if the panels/frames were supplied shorter than ordered, you need to supply photographs to show a tape measure being held against the panels/frames, clearly showing the measurement that was supplied.

### 2. Submitting a Warranty Request Form to your Sales Coordinator

a) Fill out the Warranty Request Form

b) Include images/videos

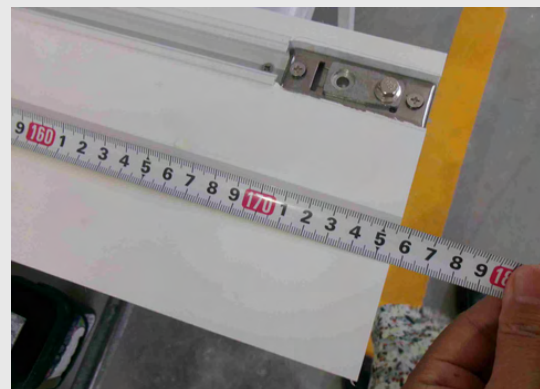

Please Note: You can request a copy of the Warranty Request Form by emailing your Sales Coordinator or contacting [info@pacificwholesale.com.au](mailto:info@pacificwholesale.com.au)



# REPLACEMENT REQUESTS

## **Customer Charge Replacements (Reworks)**

Similar as a warranty remake, a customer charge replacement (also known as a rework), requires the provision of clear and accurate information which is essential to ensure a smooth and efficient resolution.

To get started, please provide:

1. The original order number – this allows us to reference the exact measurements and specifications for a perfect match.
2. A clear description of the issue and a list of the specific parts required.

For customer charge replacements, images and evidence are not mandatory – but can be helpful if you're unsure which parts need replacing. Our team is always happy to assist in identifying what's needed based on your photos or notes.

By following this process, we can ensure that any replacements are delivered quickly, accurately, and hassle-free.

# SAMPLES & SWATCHES



**Blade Colour Swatches**



**Panel Sample**



**Channels & Frames Sample**

